

## **READ AND SAVE THESE INSTRUCTIONS**

Luna

*Thank you for purchasing a Gulf Coast Fans product. It will provide years of cost efficient comfort. With over a decade of experience in ensuring quality workmanship at an affordable price, we stand behind our product and we hope you will too.*

### **IMPORTANT PRECAUTIONS**

- 1** Read these instructions carefully before you start.
- 2** Turn off the power at the source before installation, servicing, or cleaning.
- 3** WARNING--TO REDUCE THE RISK OF FIRE OR ELECTRIC SHOCK, DO NOT USE THIS FAN WITH ANY SOLID STATE SPEED CONTROL DEVICE. USE ONLY GULF COAST CONTROLS.
- 4** WARNING--TO REDUCE THE RISK OF PERSONAL INJURY, DO NOT BEND THE BLADE IRONS WHEN INSTALLING ON BLADES, BALANCING THE BLADES, OR CLEANING THE FAN. DO NOT INSERT FOREIGN OBJECTS IN BETWEEN ROTATING FAN BLADES.
- 5** WARNING--TO REDUCE THE RISK OF FIRE, ELECTRIC SHOCK, OR PERSONAL INJURY, MOUNT FAN TO AN OUTLET BOX MARKED "ACCEPTABLE FOR FAN SUPPORT" AND USE THE MOUNTING SCREWS PROVIDED WITH THE OUTLET BOX.
- 6** If you don't feel comfortable hanging and wiring this fan, we recommend that you hire a qualified electrician to install it.
- 7** All wiring and electrical connections must meet the National Electrical Code and any local codes that may apply.
- 8** After installation, fan blades must be at least seven (7) feet from the floor.

To begin with, the site of installation must be clear of any obstructions. Walls, cabinet or cupboard doors, and AC/heating vents (strong air currents will cause fan to wobble ) are common obstructions. Also, you will need a securely mounted outlet box that is listed for fan support. The only tools you will need are : A medium Phillips screwdriver, scissors or knife, common sense,

**I. Inventory the parts**

- A. Remove all of the parts from the top styrofoam and remove the styrofoam. Use this top piece to support the fan during preliminary assembly.
- B. Remove all parts from plastic bags, including the screw package.

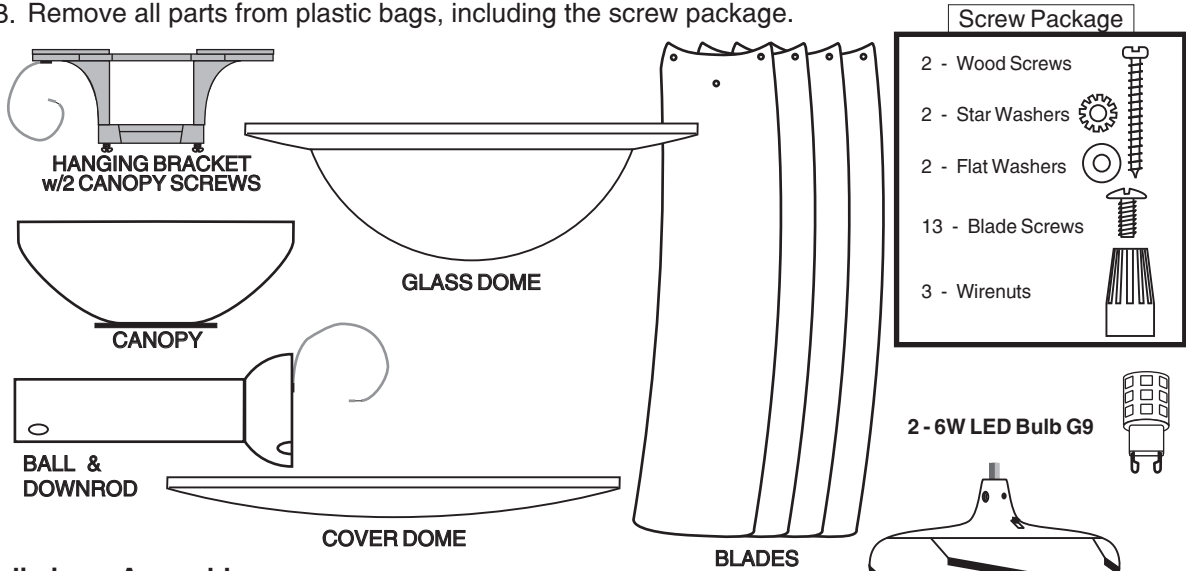

**II. Preliminary Assembly.**

- A. Remove the Glass Dome from the motor assembly. See Fig 1. Hold the top of the motor with one hand and palm the glass firmly with the other hand. Turn the glass left (CCW looking up) and let gravity drop it down.
- B.1. Remove the 1/4"-20x1 3/16" threaded pin from coupler and loosen the set screw. See Fig 2.
- 2. a. If you are using a longer downrod than is provided, loosen the set screw on the ball, slide the ball down the downrod and remove. Replace the pin in the new downrod and slide the ball up so that the pin is in the slot in the ball. Tighten the set screw. Fig. 3.
- b. The black Protective Ring in the canopy hole is to protect the motor housing during installation. It can be cut away later, but some prefer to remove it now, especially if the material is dense.
- 3. Place the downrod/ball combination through the canopy. Feed the fans wires through the downrod and insert downrod into the top of the motor housing. Align the holes in the downrod with those in the coupler. Fig.4
- 4. Insert the threaded pin through the larger hole in the motor housing, through the downrod and thread it into the opposite side of the motor housing. Tighten the set screw against the downrod firmly.
- 5. Make sure all of the screws are tight. At this time you may want to shorten the wires from the fan to 6" from the ball. This helps when you tuck the wires into outlet box.

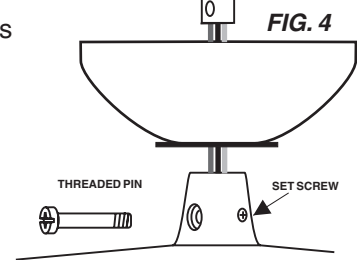
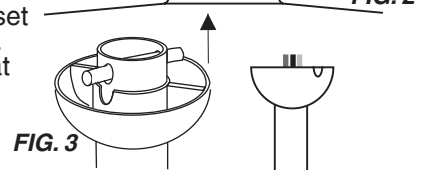
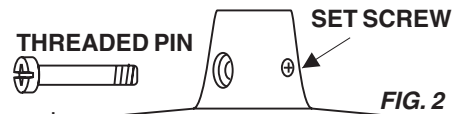
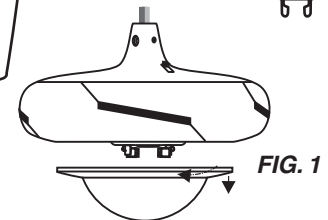

**WARNING - To Reduce The Risk Of Fire, Electric Shock, Or Personal Injury Mount Fan To An Outlet Box Marked "Acceptable For Fan Support" And Use The Mounting Screws Provided With The Outlet Box.**

- C.1. Take the hanging bracket and secure it to the outlet box (marked Acceptable For Fan Support) using the mounting screws provided with the outlet box, Fig 5. Tighten them evenly. If you are mounting the fan directly to the building structure, use the wood screws provided, and secure to a joist.
- 2. Remove one canopy screw (also Fig 5) and loosen the other. Make sure all of the wires are accessible and are not being pinched. Also, make sure the bracket doesn't wobble.

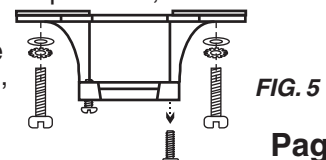

### III. Now to hang the fan...

Holding the fan carefully, lift it up to hanging bracket. Place the ball into cradle of the bracket. Turn the entire motor assembly until it locks into place. The tab on the bracket must be in the groove in the ball. Make sure the wires are not being pinched.

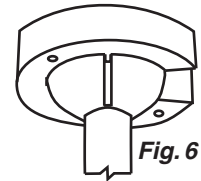

Fig. 6

### IV. Wiring instructions.

This fan can be operated by a wall control or remote control unit. The basic wiring instructions below are for a wall control. Please refer to the instructions provided with the wall control. For use with a remote control refer to the wiring instructions provided with the remote control. Keep in mind, the supply wire colors may vary. (The wire colors in parentheses are commonly found in existing structures.) Use the large orange wirenuts to make the connections. Please be sure power supply is off!

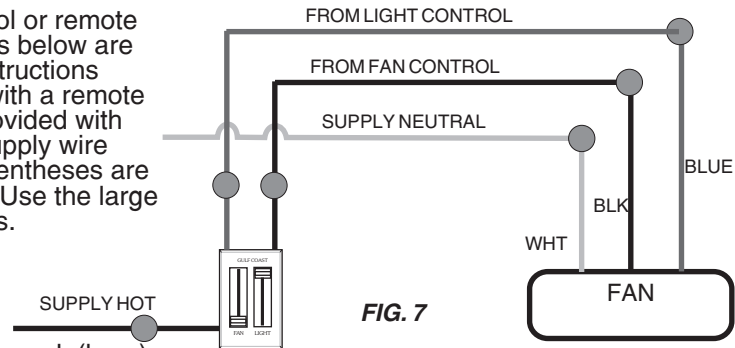

FIG. 7

1. Green ground wires to outlet box ground. (bare)
2. Black wire from fan to (black) wire from fan control.
3. Blue wire from fan to (red) wire from light control.

Now tuck the wires and wirenuts carefully into outlet box. Make sure wirenuts remain tightly on connections.

### V. Final Assembly

- A. Now is the time to remove the protective ring from the inside edge of the canopy - cut away with scissors. With the motor in place and the wires out of the way, slide the canopy up to the hanging bracket. The canopy screw in the bracket will come through the large end of the key slot in the canopy. Fig. 8. Turn the canopy slightly, counter-clockwise, to hold in place, and insert remaining canopy screw. Tighten the screws.

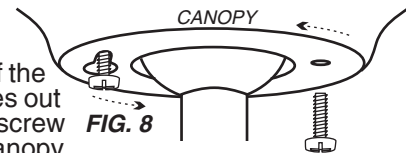

FIG. 8

- B.1. Note the side of the blade you want to show. Now slide a blade into one of the slots in the motor housing. The three holes should line up easily. See Left side of Fig. 9
2. Using the 3/16"-32x3/8" blade screws, three of each per blade, secure blade to motor. Repeat this procedure with the rest of the blades. You will have at least one screw left over; this is a spare. Be sure all of the screws are tight. Right side of Fig. 9

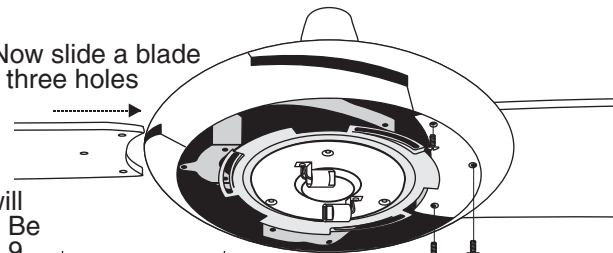

FIG. 9

- C. Now you must decide whether to use the included LED light or just the cover.

1. a. If you will **not** be using the LED light fixture, the fixture itself must be removed from the fan. Remove the three screws attaching it to the fan. Disconnect the wires at the connectors by pulling firmly on both sides. See Fig. 10.

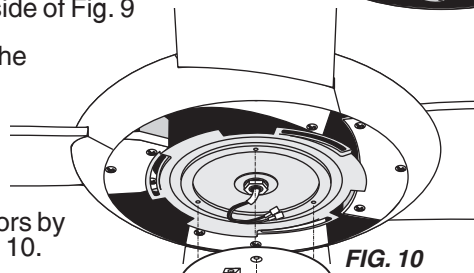

FIG. 10

- b. If you **will** be using the LED light, now is the time to install the bulbs. To install the LED bulb, simply push the flat contacts into the socket. See Fig 11.

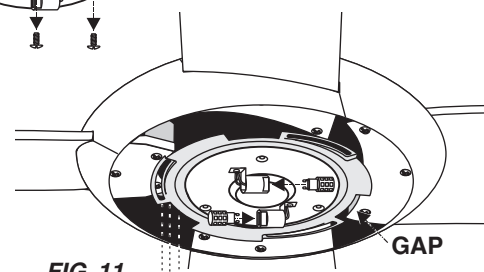
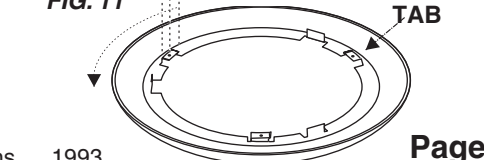

FIG. 11

2. Both Glass Dome and Cover Dome have a mounting ring. Align the dimpled tabs of the plate with the gaps in the fan's mounting plate, lift up into position and rotate clockwise to secure. See Fig. 11.



**VI. Turn the power supply back on and prepare to be comfortable!**

The speeds are controlled using the wall control or remote control. To reverse the airflow, turn off fan and let blades come to a complete stop. The reverse switch is located on top of the motor; slide it to the other side.

VII. Troubleshooting	
Fan won't run -	Check power supply. Reverse switch is not fully engaged one way. Check wirenut connections at fan and switch. Double check wiring diagrams.
Fan makes noise -	Please allow 24 hrs to fully seat bearings Screw(s) is(are) loose somewhere. Ball is not seated properly in hanging bracket. Variable control (solid-state dimmer) in the circuit.
Fan wobbles -	Bracket is loose at the ceiling. Loose screw at top of fan. Ball is not seated properly in hanging bracket.

**FIG. 12**  
**Complete**  
**Assembly**  
**Breakdown**

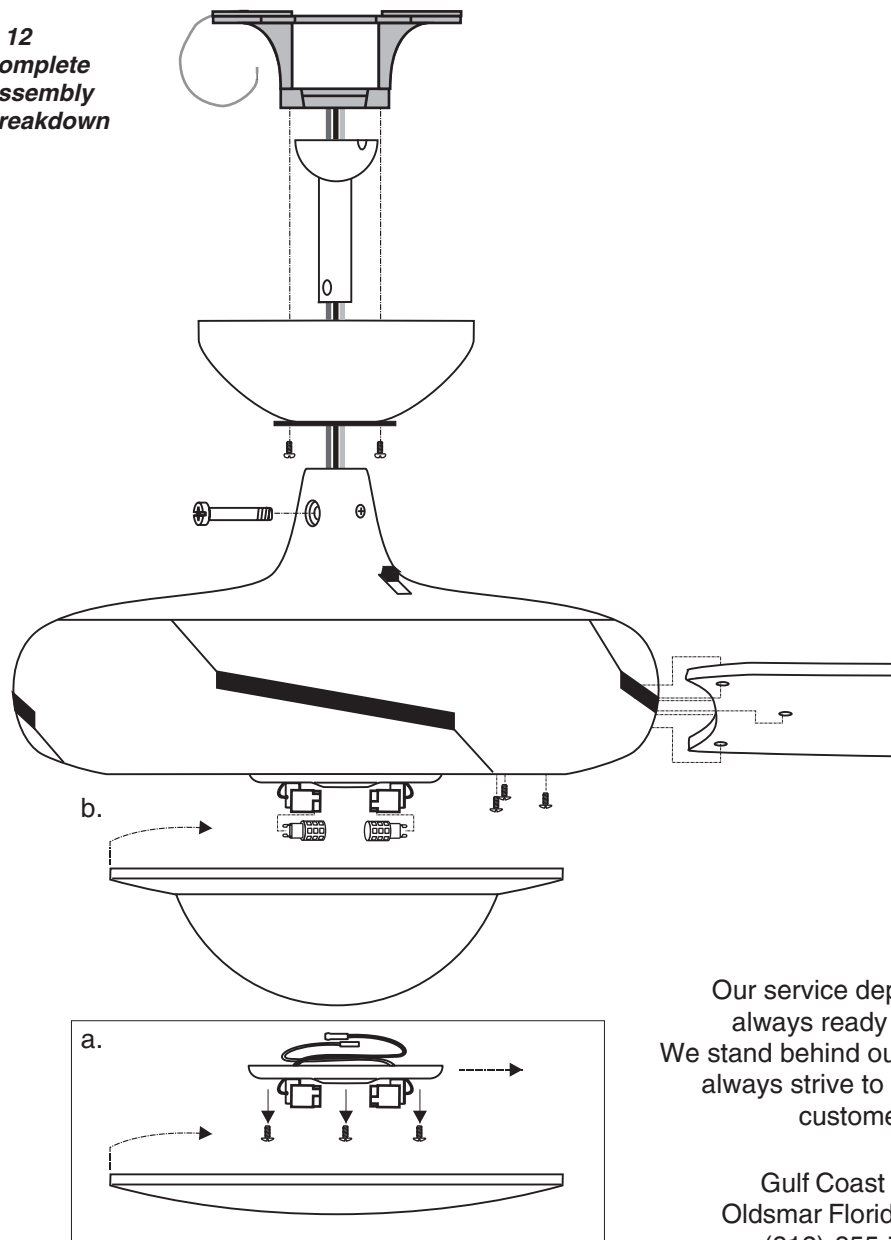

Our service department is  
always ready to help.  
We stand behind our product and  
always strive to satisfy our  
customer.

Gulf Coast Fans  
Oldsmar Florida 34677  
(813)-855-7384